

# Arches and Window Features

Window Panels may be used alone as design elements or below many window styles. Creative painting of window panels will also lend interesting decorative effects. Our CDM arches add depth and distinction to any window or door.



# ARCHES

## 102 SERIES



102 Series Application shown with 102K1 Keystone

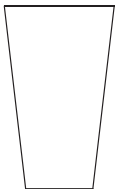

### Keystone for 102 Series Arches

<b>PART #</b>	102K1
<b>HEIGHT</b>	12 <sup>1</sup> / <sub>4</sub> "
<b>A WIDTH</b>	4 <sup>1</sup> / <sub>2</sub> "
<b>B WIDTH</b>	7 <sup>1</sup> / <sub>2</sub> "
<b>PROJ</b>	3 <sup>3</sup> / <sub>8</sub> "

Note: AM102/72 shipped as two pieces with a keystone.

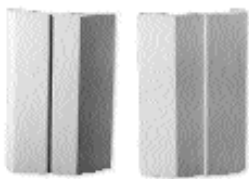

### Plinths for 102 Series

Sold in Pairs

<b>PART #</b>	102AP/PL
<b>HEIGHT</b>	16"
<b>A WIDTH</b>	10 <sup>1</sup> / <sub>2</sub> "
<b>PROJ</b>	2 <sup>7</sup> / <sub>8</sub> "

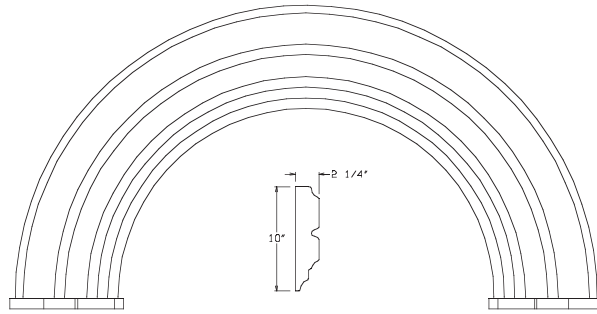

10" Moulded Arch with 2<sup>1</sup>/<sub>4</sub>" Projection Matches Linear Mouldings 102AP/16 & 102AP/8 Arch feet are moulded to 102 Series Arches Size Availability to the right.

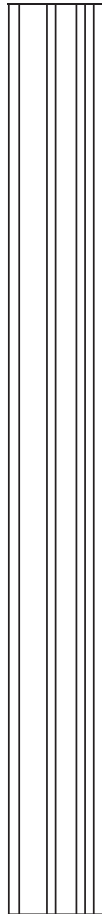

### 102 SERIES PILASTERS

PART #	H	WIDTH	P
102AP/96	8'	10"	2 <sup>1</sup> / <sub>4</sub> "
102AP/108	9'	10"	2 <sup>1</sup> / <sub>4</sub> "

**\*NOTE:**  
ARCHES GREATER THAN 4' COME IN 2 PIECES

102 Series Arches available in the following sizes:

PART #	INSIDE DIA
AM102/24 <sup>1</sup> / <sub>8</sub>	24 <sup>1</sup> / <sub>8</sub> "
AM102/25 <sup>5</sup> / <sub>8</sub>	25 <sup>5</sup> / <sub>8</sub> "
AM102/28 <sup>3</sup> / <sub>8</sub>	28 <sup>3</sup> / <sub>8</sub> "
AM102/29 <sup>5</sup> / <sub>8</sub>	29 <sup>5</sup> / <sub>8</sub> "
AM102/32	32"
AM102/33 <sup>5</sup> / <sub>8</sub>	33 <sup>5</sup> / <sub>8</sub> "
AM102/35	35"
AM102/36	36"
AM102/37 <sup>5</sup> / <sub>8</sub>	37 <sup>5</sup> / <sub>8</sub> "
AM102/39	39"
AM102/40	40"
AM102/41 <sup>5</sup> / <sub>8</sub>	41 <sup>5</sup> / <sub>8</sub> "
AM102/48	48"
AM102/49 <sup>3</sup> / <sub>4</sub>	49 <sup>3</sup> / <sub>4</sub> "
AM102/50	50"
AM102/52	52"
AM102/54	54"
AM102/56 <sup>1</sup> / <sub>2</sub>	56 <sup>1</sup> / <sub>2</sub> "
AM102/60	60"
AM102/61	61"
AM102/62	62"
AM102/64 <sup>1</sup> / <sub>2</sub>	64 <sup>1</sup> / <sub>2</sub> "
AM102/65	65"
AM102/68	68" (2 pc.)
AM102/70	70" (2 pc.)
AM102/72	72"

AVAILABLE IN ANY SIZE

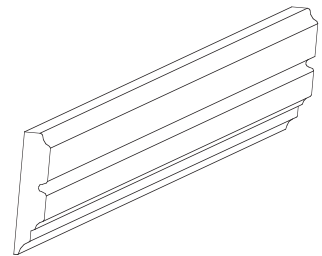

### 102 Series 10" Linear Moulding

PART #	H	LENGTH	PROJ
102AP/192	10"	16'	2 <sup>1</sup> / <sub>4</sub> "

WINDOW FEATURES & ARCHES



# ARCHES

## 102 PALLADIAN SERIES

### 102 Palladian Arches

WINDOW FEATURES & ARCHES

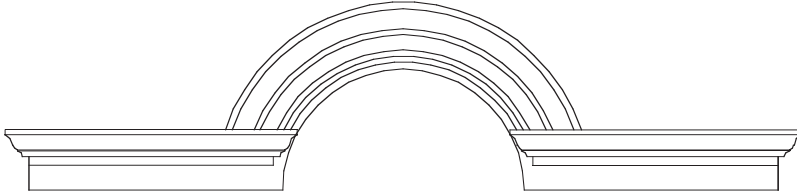

Arch Projection: 2 1/4" Crosshead Projection: 4 1/4"  
 Custom sizing available for crossheads  
 Order Crossheads by "A WIDTHS" Example: AMS10236/18\*  
 Specify A WIDTH up to 37 5/8"  
 For keystone use 102K1

PART#	ARCH INSIDE DIAMETER	MAX. CROSSHEAD A WIDTH
AMS10224	24 1/8"	37 5/8"
AMS10227	24 1/8"	37 5/8"
AMS10232	32"	37 5/8"
AMS10234	33 5/8"	37 5/8"
AMS10235	35"	37 5/8"
AMS10236	36"	37 5/8"
AMS10238	37 5/8"	37 5/8"
AMS10240	40"	37 5/8"
AMS10244	44"	37 5/8"
AMS10248	48"	37 5/8"

**NOTE:**  
 Inside height of arch is equivalent to radius + 2"

Inside height of AMS10232 is 16"

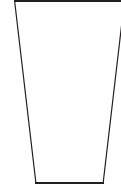

### Keystone for 102 Series Arches

PART #	102K1
HEIGHT	12 1/4"
A WIDTH	4 1/2"
B WIDTH	7 1/2"
PROJ	3 3/8"

**Note:** AM102/72 shipped as two pieces with a keystone.

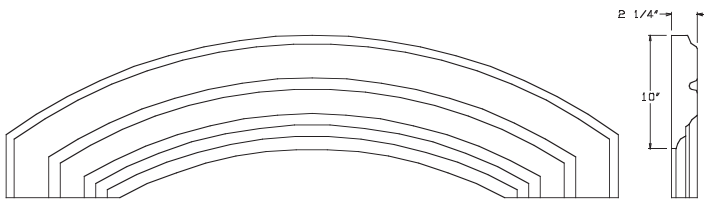

PART#	A WIDTH	RADIUS
AT102/34R36	33 3/4"	35 3/4"
AT102/62R60	62 1/4"	60"

AVAILABLE IN ANY SIZE  
 \*USE WITH 102 SERIES PILASTER



# ARCHES

## 55 & 585 SERIES



Use CDM Arch Series with half round Sunbursts to achieve a decorative finish for windows.

### 55 Series Arches

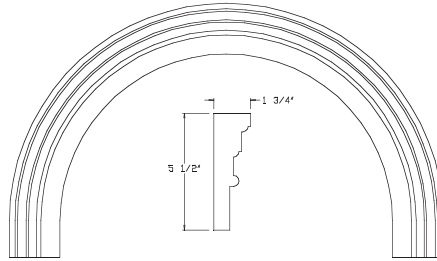

5 1/2" Moulded Arch with 1 3/4" Projection Matches Linear Moulding 55AM, 55AM/12 & 55AM/8 Arch feet moulded separately except on 40" & 43" arches.

55 Series Arches available for the following size windows

PART #	A WIDTH	PART #	A WIDTH
AM55/23 <sup>5/8</sup>	23 <sup>5/8</sup> "	AM55/48	48"
AM55/32	32"	AM55/52	52"
AM55/33 <sup>5/8</sup>	33 <sup>5/8</sup> "	AM55/56	56"
AM55/36	36"	AM55/60	60"
AM55/37 <sup>5/8</sup>	37 <sup>5/8</sup> "	AM55/64	64"
AM55/40	40"	AM55/68	68"
AM55/43	43"	AM55/70	70"
AM55/44 <sup>3/4</sup>	44 <sup>3/4</sup> "	AM55/72	72"
		AM55/76	76"



WINDOW FEATURES & ARCHES

### 585 Series Arches

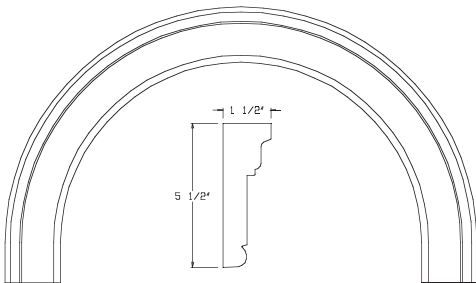

5 1/2" Moulded Arch with 1 1/2" Projection Matches Linear Moulding 585AM.

585 Series Arches available for the following size windows

PART #	A WIDTH	PART #	A WIDTH
AM585/28	28"	AM585/40	40"
AM585/33 <sup>5/8</sup>	33 <sup>5/8</sup> "	AM585/48	48"
AM585/36	36"	AM585/64	64"
AM585/37 <sup>5/8</sup>	37 <sup>5/8</sup> "	AM585/72 <sup>5/8</sup>	72 <sup>5/8</sup> "

### 55 Series Palladian Arch

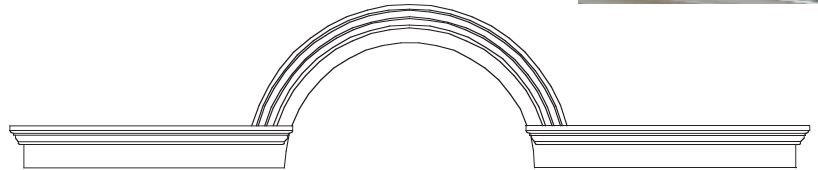

Arch projection: 1 3/4" Crosshead projection: 3"  
Custom sizes available for crossheads up to 37<sup>5/8</sup>".  
Order crossheads by A width: Example AMS5536/18.  
For keystone use 55/K1

PART #	AM5536
ARCH INS. DIAMETER	36"
MAX CROSSHEAD A WIDTH	37 <sup>5/8</sup> "

### Keystone for 55 Series Arches

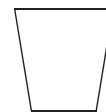

PART #	55/K1
HEIGHT	7 1/4"
A WIDTH	4"
B WIDTH	6"
PROJ	2 5/8"

### Keystone for 585 Series Arches



PART #	585AM/K1
HEIGHT	6 7/8"
A WIDTH	3 1/8"
B WIDTH	5 1/8"
PROJ	2 1/2"

### 55 Series Rosette

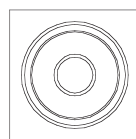

PART #	55 ROSETTE
HEIGHT	5 1/2"
WIDTH	5 1/2"
PROJ	1 3/4"

### 55 Series Plinth

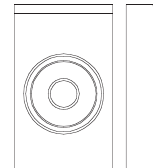

PART #	55AM/PLINTH
HEIGHT	9 1/2"
WIDTH	5 1/2"
PROJ	1 3/4"



# ARCHES

WINDOW FEATURES  
& ARCHES

## Half Round Adams Casing

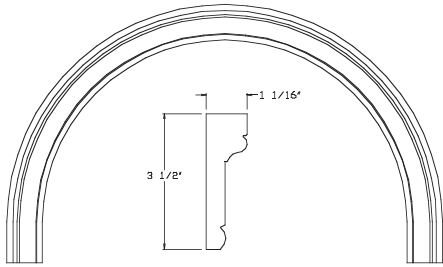

3 1/2" Moulded Arch with 1 1/16" Projection  
Matches Linear Moulding AC416

PART #	A WIDTH
AC416/36	36"
AVAILABLE IN ANY SIZE	

## 67 AM Series Arches

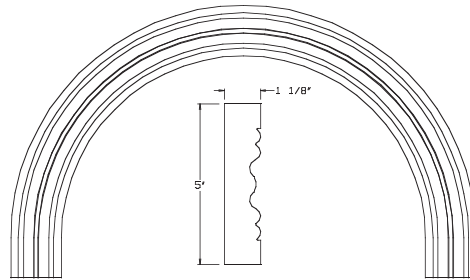

5" Moulded Arch with 1 1/8" Projection  
Matches Linear Moulding 67AM

PART #	A WIDTH
AM67/36	36"
AVAILABLE IN ANY SIZE	

## 76 AM Series Arches

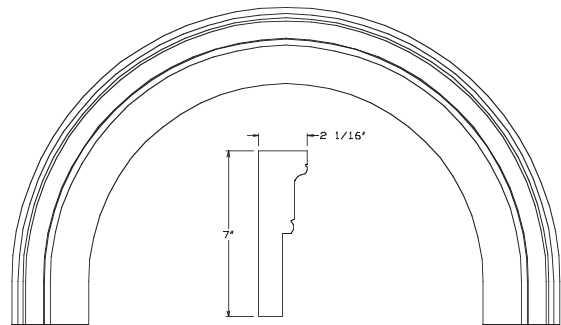

7" Moulded Arch with 2 1/16" Projection  
Matches Linear Moulding 76AM

PART #	A WIDTH
AM76/36	36"
AVAILABLE IN ANY SIZE	

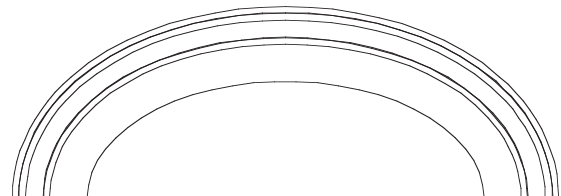

7" Moulded Arch with 2 1/16" Projection  
Matches Linear Moulding 76AM

PART #	A WIDTH	PROJ	INSIDE H
ET76/3711	37 1/8"	2 1/16"	10 7/8"



# ARCHES

## 77, 78 & 87 SERIES



WINDOW FEATURES  
& ARCHES

### 77 Series Arches

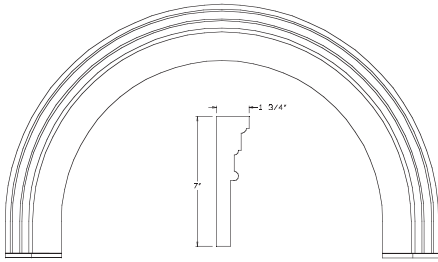

77 Series Arches available for the following size windows

PART #	INSIDE DIA
AM77/40	40"
AM77/70 <sup>1/4</sup>	70 <sup>1/4</sup> "

### 78 Series Arches

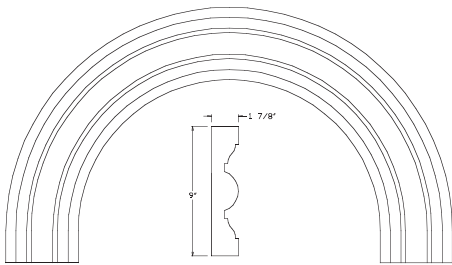

78 Series Arches available for the following size windows

PART #	INSIDE DIA
AM78/37 <sup>5/8</sup>	37 <sup>5/8</sup> "
AM78/48	48"

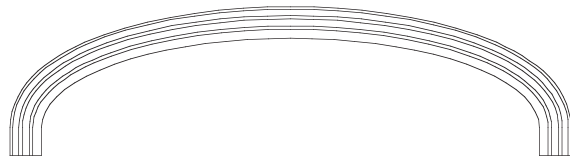

### 87 Series Elliptical Arches

4 1/2" Moulded Elliptical Arches For Keystone use 87K1 Keystone Plinths shown below matches Andersen® Elliptical Windows ET-6 and ET-8

PART #	INS HEIGHT	A WIDTH	PROJ
87-ET6	16 <sup>3/4</sup> "	71 <sup>1/4</sup> "	1 1/2"
87-ET8	21"	95 <sup>1/4</sup> "	1 1/2"

3 1/2" Flat Casing for Andersen® Elliptical Windows

PART #	INS HEIGHT	A WIDTH	PROJ
FA104/ET-6	16 <sup>3/4</sup> "	71 <sup>1/4</sup> "	1 1/2"
FA104/ET-8	21"	95 <sup>1/4</sup> "	1 1/2"

### 87 Series Arches

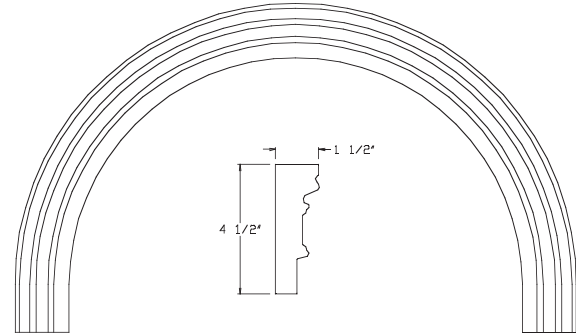

4 1/2" Moulded Arch with 1 1/2" Projection

Matches Linear Moulding 87AM

Arch feet moulded separately - (included with arch)

87 Series Arches available for the following size windows

PART #	INSIDE DIA	PART #	INSIDE DIA
AM87/24 <sup>1/8</sup>	24 <sup>1/8</sup> "	AM87/37 <sup>5/8</sup>	37 <sup>5/8</sup> "
AM87/25 <sup>5/8</sup>	25 <sup>5/8</sup> "	AM87/41 <sup>5/8</sup>	41 <sup>5/8</sup> "
AM87/28 <sup>3/8</sup>	28 <sup>3/8</sup> "	AM87/48	48"
AM87/29 <sup>5/8</sup>	29 <sup>5/8</sup> "	AM87/56 <sup>1/2</sup>	56 <sup>1/2</sup> "
AM87/33 <sup>5/8</sup>	33 <sup>5/8</sup> "	AM87/71 <sup>7/8</sup>	71 <sup>7/8</sup> "

### 87 Series 4 1/2" Rosette Plinth

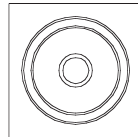

PART #	87R
HEIGHT	4 1/2"
A WIDTH	4 1/2"
PROJ	1 1/2"

### Keystone for 87 Series Arches

PART #	87K1
HEIGHT	6"
A WIDTH	2 <sup>5/8</sup> "
B WIDTH	4 <sup>3/4</sup> "
PROJ	2 <sup>3/8</sup> "

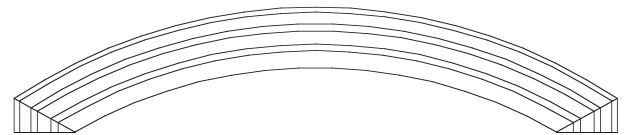

### 87 Series Arched Tops

4 1/2" Moulded Arched Tops For Keystone(s) use 87K1 matches Andersen® Arch Top Windows

PART #	A WIDTH	PROJ	ANDERSON® #
AWM87/36	36"	1 1/2"	AFCP3
AWM87/48	48"	1 1/2"	AFC2
AWM87/56 <sup>1/2</sup>	36"	1 1/2"	AFCW2
AWM87/71 <sup>1/4</sup>	71 <sup>1/4</sup> "	1 1/2"	AFFW6

### 87 Series Keystone Plinths

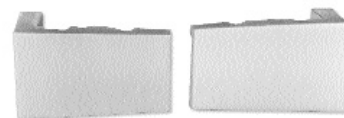

PART #	87-ET6/8K
HEIGHT	3 1/8"
A WIDTH	57 <sup>1/16</sup> "
PROJ	2 1/8"



# ARCHES

## 88, 89 & BMTH SERIES

### 88 Series Arches

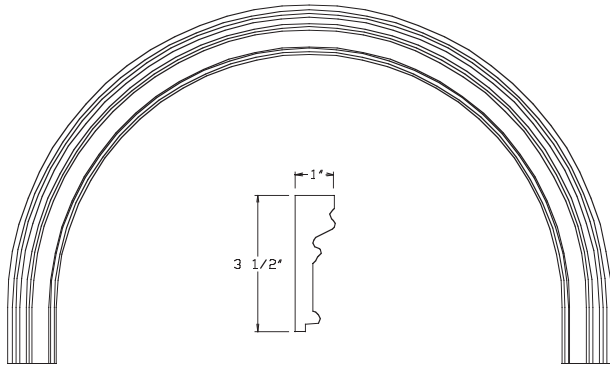

3 1/2" Moulded Arch with 1" projection matches Linear Moulding 88AM Arch feet moulded separately.

88 Series Arches available for the following sizes:

PART #	INSIDE DIA	PART #	INSIDE DIA
AM88/24	24"	AM88/48	48"
AM88/28	28"	AM88/52	52"
AM88/29 <sup>5/8</sup>	29 <sup>5/8</sup> "	AM88/55	55"
AM88/32	32"	AM88/60	60"
AM88/33 <sup>3/5</sup>	33 <sup>3/5</sup> "	AM88K/33 <sup>5/8</sup>	33 <sup>5/8</sup> "
AM88/36	36"	AM88K/36	36"
AM88/37 <sup>5/8</sup>	37 <sup>5/8</sup> "	AM88K/37 <sup>5/8</sup>	37 <sup>5/8</sup> "
AM88/40	40"	AM88K/52	52"
AM88/41 <sup>5/8</sup>	41 <sup>5/8</sup> "	AM88K/70	70"
AM88/43	43"		

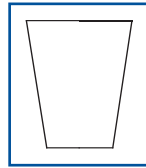

Keystone for 88 Series Arches

PART #	88/K1
HEIGHT	4 1/8"
A WIDTH	2 11/16"
B WIDTH	4"
PROJ	2"

### 89 Series Palladian Arches

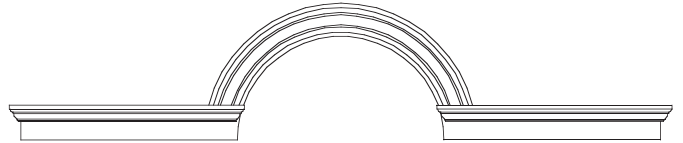

Arch projection: 1 1/8" Crosshead projection: 3"  
 Custom sizes available for crossheads up to 37<sup>5/8</sup>"  
 Order crossheads by A width: Example AMS8936/20  
 For keystone use 89/K1

PART #	AMS8936	AMS8944
ARCH INS. DIAMETER	36"	44"
MAX CROSSHEAD A WIDTH	37 <sup>5/8</sup> "	37 <sup>5/8</sup> "

### BMTH Series Brick Moulding Arches

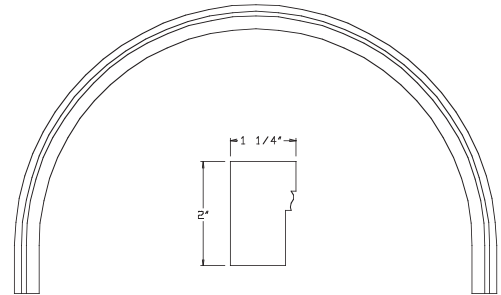

2" Brick Moulding Arches with 1 1/4" projection matches Linear Moulding BM216 on Page 48.

BMTH Series Arches available for the following size windows

PART #	INSIDE DIA
BMTH/28	28"
BMTH/32	32"
BMTH/36	36"
BMTH/48	48"
BMTH/64	64"
BMTH/72	72"

AVAILABLE IN ANY SIZE

### Keystone for BMTH Series Arches

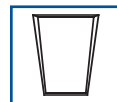

PART #	BMK
HEIGHT	3 11/16"
A WIDTH	1 15/16"
B WIDTH	3"
PROJ	2 3/8"

### 89 Series Arches

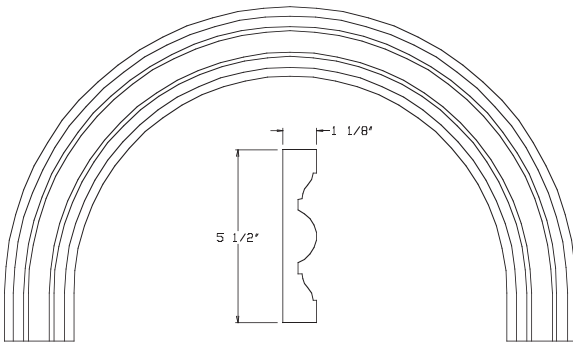

5 1/2" Moulded Arch with 1 1/8" projection matches Linear Moulding 89AM Arch feet moulded separately.

89 Series Arches available for the following sizes:

PART #	INSIDE DIA
AM89/33 <sup>5/8</sup>	33 <sup>5/8</sup> "
AM89/36	36"
AM89/64	64"

### Keystone for 89 Series Arches

PART #	89K1
HEIGHT	6 7/8"
A WIDTH	3 3/8"
B WIDTH	5 1/8"
PROJ	3 1/2"

# ARCHES

## FLAT ARCH SERIES



### FA104, FA106, FA108 & FA206 Series Arches

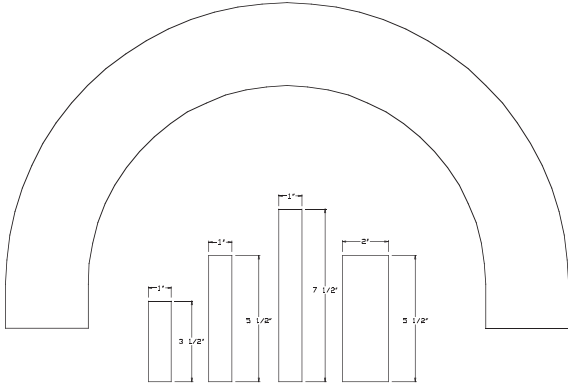

#### FA104 Series 3 1/2" Arches 3 1/2" Arch Casing with 1" Projection

PART #	INSIDE DIA
FA104/24 1/8	24 1/8"
AVAILABLE IN ANY SIZE	

#### FA106 Series 5 1/2" Arches 5 1/2" Arch Casing with 1" Projection

PART #	INSIDE DIA
FA106/24	24"
AVAILABLE IN ANY SIZE	

#### FA108 Series 7 1/2" Arches 7 1/2" Arch Casing with 1" Projection

PART #	INSIDE DIA
FA108/36	36"
AVAILABLE IN ANY SIZE	

#### FA206 Series 5 1/2" Arches 5 1/2" Arch Casing with 1 1/2" Projection

PART #	INSIDE DIA
FA206/22	22"
AVAILABLE IN ANY SIZE	

WINDOW FEATURES & ARCHES

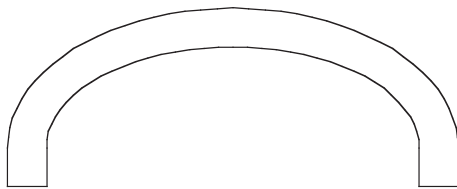

#### Flat Elliptical Casing

PART #	FE107/67
A WIDTH	67"
PROJ	1"
AVAILABLE IN ANY SIZE	

#### Keystone for FA SERIES ARCHES

PART #	H	A WIDTH	B WIDTH	PROJ
FA104/K1	4 5/8"	2 1/2"	3 3/4"	1 5/8"
FA106/K1	6 1/2"	3 1/2"	6"	1 5/8"
FA108/K1	8 5/8"	4"	7"	1 5/8"

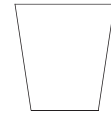

#### Rosette Plinth for FA104 Series Arches

PART #	WIDTH	LENGTH	PROJ
FA104/PB	3 7/8"	3 7/8"	1 5/8"

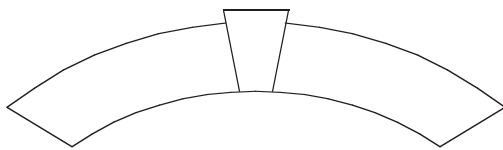
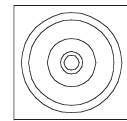

#### AWFK8 Series Arched Tops

##### 7 1/2" Flat Arched Top with Attached Keystone

PART #	A WIDTH	B WIDTH	PROJ
AWFK8/40	40"	54"	1 1/2"
AWFK8/48	48"	62"	1 1/2"
AWFK8/52	52"	66"	1 1/2"
AWFK8/84	84"	98"	1 1/2"
AWFK8/90	90"	104"	1 1/2"

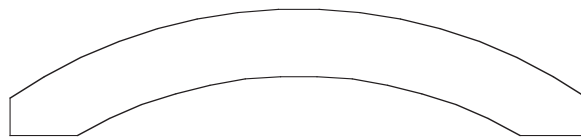

#### AT104, AT106, AT108 Series Arch Tops

PART #	A WIDTH	B WIDTH	PROJ	RADIUS
AT104/36	36"	43"	1"	36"
AT106/36R30	36"	47"	1"	30"
AT108/72	72"	87"	1"	72"
AVAILABLE IN ANY SIZE				

#### Keystone for FA206 SERIES ARCHES

PART #	H	A WIDTH	B WIDTH	PROJ
FA206/K1	7 7/8"	6 3/4"	9 7/8"	2"
FA206/K2	6 3/4"	3 7/8"	6 1/4"	2"

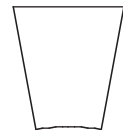

Flat arch, elliptical, oval and rounds are available in any size when dimensions or template are provided.